

150 R

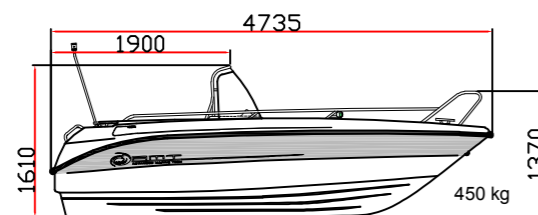

160 R

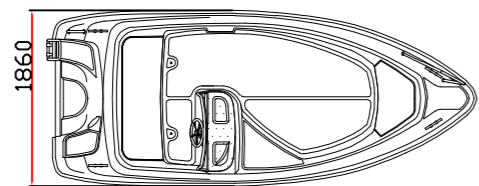
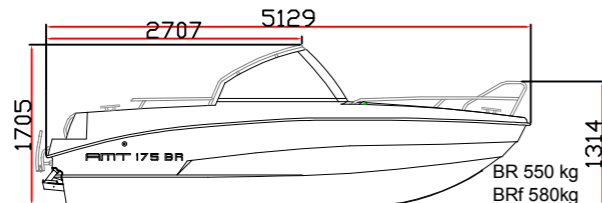
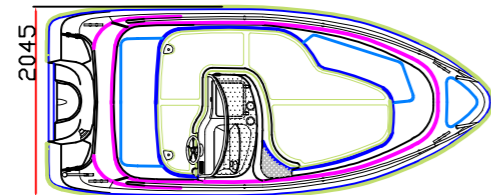

175 BR / BRf

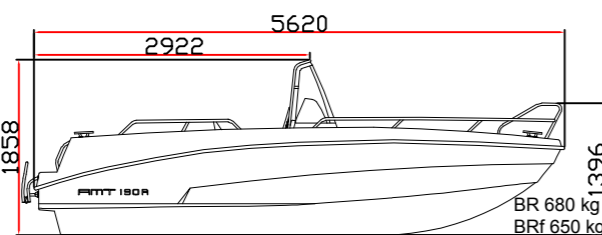
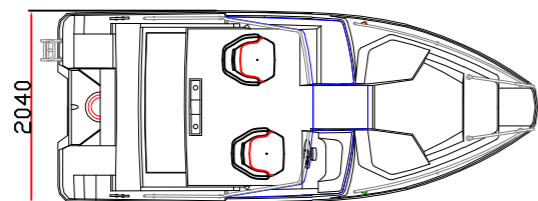

190 R / Rf

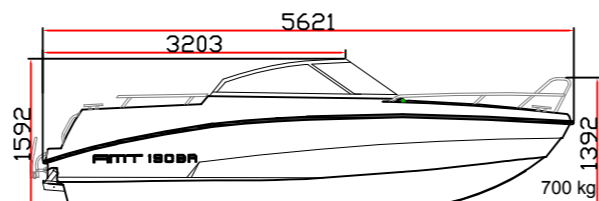
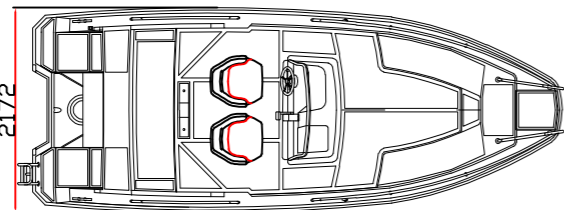

190 BR / BRf

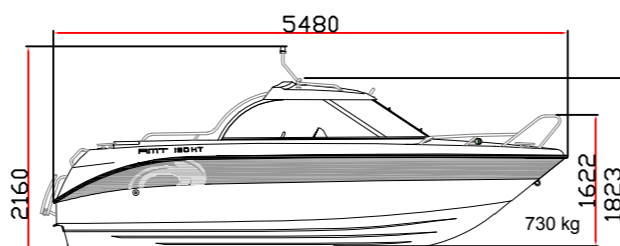
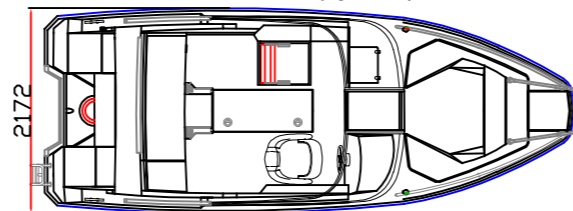

190 HT

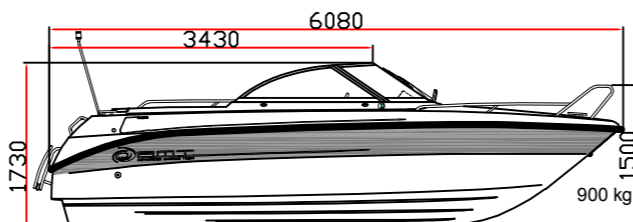
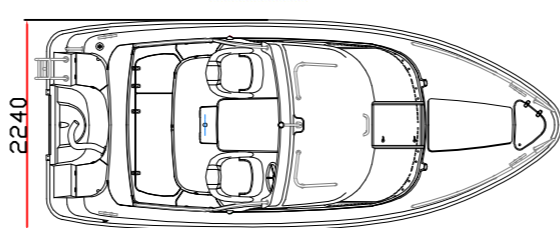

200 BR

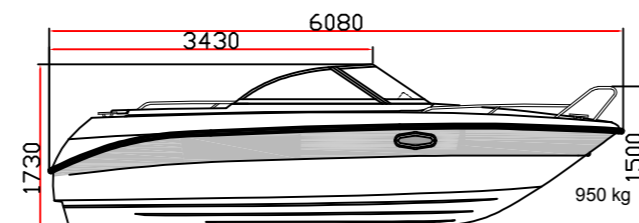
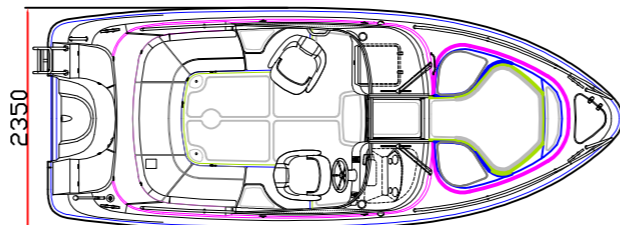

200 DC

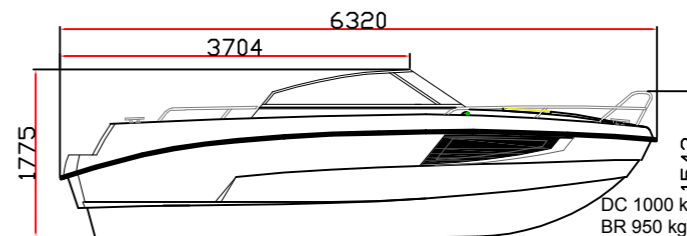
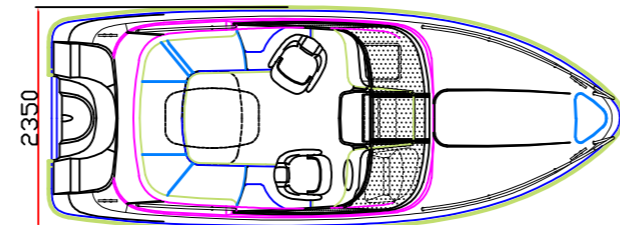

210 DC / BR

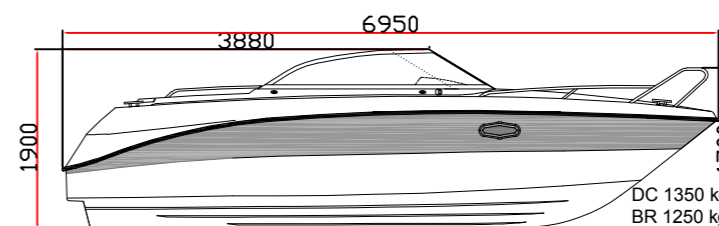
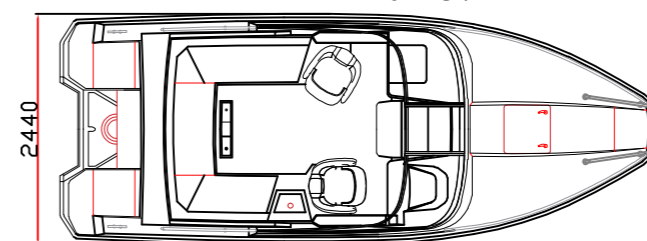

230 DC / BR

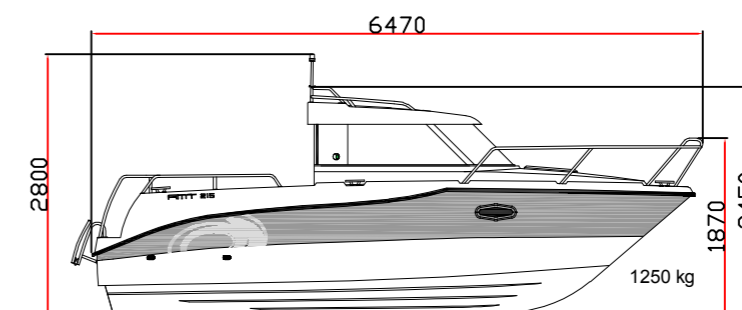
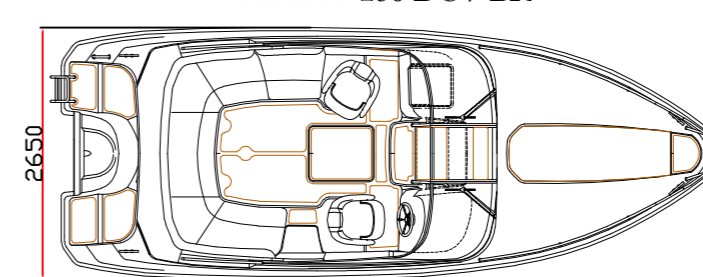

215 PH

